

RPC-.MB-...

time relays



RPC-1MB-UNI



RPC-2MB-A230

- Multifunction time relays (10 time functions; 8 time ranges)
- Cadmium - free contacts 1 CO and 2 CO
- AC and AC/DC input voltages
- Cover - modular, width 17,5 mm
- Direct mounting on 35 mm rail mount acc. to EN 60715
- Applications: in low-voltage systems
- Compliance with standard EN 61812-1
- Recognitions, certifications, directives: RoHS, **CE** **EAC**

Output circuit - contact data

Number and type of contacts		1 CO	2 CO
Contact material		AgSnO ₂	
Max. switching voltage		300 V AC	
Rated load	AC1	16 A / 250 V AC	8 A / 250 V AC
	DC1	16 A / 24 V DC	8 A / 24 V DC
	DC1	0,3 A / 250 V DC	0,3 A / 250 V DC
Rated current		16 A / 250 V AC	8 A / 250 V AC
Max. breaking capacity		AC1 4 000 VA	2 000 VA
Min. breaking capacity		1 W 10 mA	
Contact resistance		≤ 100 mΩ	
Max. operating frequency		600 cycles/hour at rated load AC1	
Input circuit			
Rated voltage	50/60 Hz AC	230 V	terminals A1, A2
	AC: 50/60 Hz AC/DC	12...240 V	terminals (+)A1, (-)A2
Must release voltage		≥ 0,1 U _n	
Operating range of supply voltage		0,9...1,1 U _n	
Rated power consumption	AC	≤ 3,5 VA 230 V AC, 50 Hz	≤ 1,5 VA 12...240 V AC/DC, AC: 50 Hz
	DC	≤ 1,5 W 12...240 V AC/DC	
Range of supply frequency		AC 48...63 Hz	
Control contact S ①			
• min. voltage ②		0,7 U _n	
• min. time of pulse duration ②		AC: ≥ 50 ms	DC: ≥ 30 ms
• max. length of control line		10 m	
Insulation according to EN 60664-1			
Insulation rated voltage		250 V AC	
Rated surge voltage		4 000 V 1,2 / 50 μs	
Overvoltage category		III	
Insulation pollution degree		2	
Flammability class		V-0	for modular cover, UL 94
Dielectric strength	• input - output	4 000 V AC	type of insulation: basic
	• contact clearance	1 000 V AC	type of clearance: micro-disconnection
	• pole - pole	2 000 V AC	contacts 2 CO, type of insulation: basic
General data			
Electrical life	• resistive AC1	> 0,5 x 10 ⁵	16 A, 8 A, 250 V AC
Mechanical life (cycles)		> 3 x 10 ⁷	
Dimensions (L x W x H)		90 ③ x 17,5 x 64,6 mm	
Weight		contact 1 CO: 65...66 g	contacts 2 CO: 72...73 g
Ambient temperature (non-condensation and/or icing)	• storage	-40...+70 °C	
	• operating	-20...+50 °C	
Cover protection category		IP 20	EN 60529
Relative humidity		up to 85%	
Shock resistance		15 g	
Vibration resistance		0,35 mm DA 10...55 Hz	

① The control terminal S is activated by connection to A1 terminal via the external control contact S.

② Where the control signal is recognizable. ③ Length with 35 mm rail catches: 98,8 mm.

Table of codes

Table 1

Time relay code		Rated input voltage
with 1 CO contact	with 2 CO contacts	
RPC-1MB-A230	RPC-2MB-A230	230 V AC 50/60 Hz
RPC-1MB-UNI	RPC-2MB-UNI	12...240 V AC/DC AC: 50/60 Hz

Time module data

Functions	E, Wu, Bp, Bi, Ra, Wst, Wi, Esf, Esp, Est	
Time ranges	OFF - permanent switching off; ON - permanent switching on 1 s ④; 10 s; 1 min.; 10 min.; 1 h; 10 h; 1 d; 10 d	
Timing adjustment	smooth - (0,1...1) x time range (does not refer to range ON / OFF)	
Setting accuracy	± 5% ⑤ ④	
Repeatability	± 0,5% ④	
Values affecting the timing adjustment	temperature: ± 0,05% / °C supply voltage: ± 0,01% / V	
Recovery time	AC	≤ 150 ms 230 V AC, 50 Hz ≤ 400 ms 12...240 V AC/DC, AC: 50 Hz
	DC	≤ 150 ms 12...240 V AC/DC
LED indicator	green LED U ON - indication of supply voltage U green LED U flashing - measurement of T time yellow LED R ON/OFF - output relay status	

④ For first range setpoint (1 s) setting accuracy and repeatability are smaller than the given ones in technical parameters (significant influence of the operational relay operating time, processor start-time, and the moment of supply switching as referred to the AC supply course). ⑤ Calculated from the final range values, for the setting direction from minimum to maximum.

Time functions

E - ON delay.

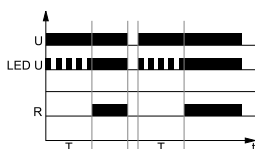

On applying the supply voltage U the set interval T begins - off-delay of the output relay R. After the interval T has lapsed, the output relay R switches on and remains on until supply voltage U is interrupted.

Wu - ON for the set interval.

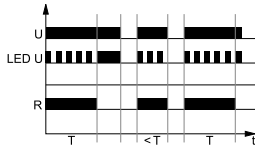

Applying the supply voltage U immediately switches the output relay R on for the set interval T. After the interval T has lapsed, the output relay R switches off.

Bp - Symmetrical cyclical operation pause first.

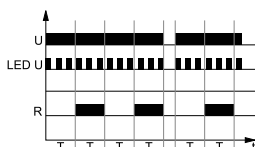

Applying the supply voltage U starts the cyclical operation from the interval T - switching the output relay R off followed by switching on the output relay R for the interval T. The cyclical operation lasts until the supply voltage U is interrupted.

U - supply voltage; R - output state of the relay; S - control contact state;
T - measured time; t - time axis

Bi - Symmetrical cyclical operation pulse first.

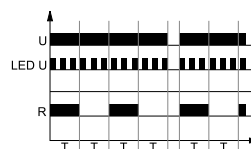

Applying the supply voltage U starts the cyclical operation from switching on the output relay R for the set interval T. After the interval T has lapsed, the output relay R switches off for the interval T. The cyclical operation lasts until the supply voltage U is interrupted.

Ra - OFF delay with the control contact S, without the interval T extension.

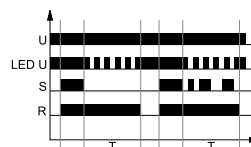

The input of the time relay is supplied with voltage U continuously. Closing of the control contact S immediately switches on the output relay R. Opening of the control contact S starts the set time of the delayed switching off of the output relay R. After the interval T has lapsed, the output relay R switches off. Opening or closing of the control contact S within the interval T does not affect the function to be performed.

Wst - ON for the set interval by closing the control contact S, with extension of the interval T - extension of the time of switching on the output relay R.

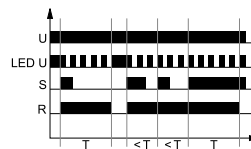

The input of the time relay is supplied with voltage U continuously. Closing of the control contact S immediately switches the output relay R on for the set interval T. After the interval T has lapsed, the output relay R is switched off. The next closing of the control contact S immediately switches on the output relay R for the interval T. In case the control contact S is closed within the interval T, the measured time is cancelled, and the interval T starts again.

Time functions

Wi - ON for the set interval controlled by closing of the control contact S, with the function of switching off the output relay R prior to the lapse of the interval T.



The input of the time relay is supplied with voltage U continuously. Closing of the control contact S starts the interval T. After the interval T has lapsed, the output relay R is switched off. Any next closing of the control contact S switches on the output relay R again. In case the control contact S is closed again during the interval T, the output relay is immediately switched off, and the measured interval is cancelled. In the course of the interval T, any opening of the control contact S does not affect the function to be performed.

Esf - ON delay with the control contact S, without the interval T extension.

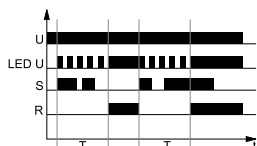

The input of the time relay is supplied with voltage U continuously. Closing of the control contact S starts the interval T - on-delay of the output relay R. After the interval T has lapsed, the output relay R switches on and remains in this position until the control contact S is closed again, which instantly switches the output relay off for the time T, and after the interval T has lapsed, the output relay R switches on again. In the course of measurement of the interval T, opening or closing of the control contact S does not affect the status of the output relay R. The output relay R may be switched on again after the current cycle has been completed.

U - supply voltage; **R** - output state of the relay; **S** - control contact state; **T** - measured time; **t** - time axis

Esp - ON delay - one cycle, with closing of the control contact S.

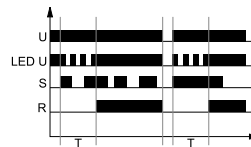

The input of the time relay is supplied with voltage U continuously. Closing of the control contact S starts the interval T, and after the interval T has lapsed, the output relay R switches on and remains in this position until the supply voltage U is interrupted. When the output relay R is on, opening or closing of the control contact S does not affect its status.

Est - ON delay with closing of the control contact S, with the interval T extended.

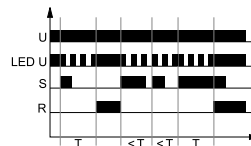

The input of the time relay is supplied with voltage U continuously. Closing of the control contact S starts the interval T, and after the interval T has lapsed, the output relay R switches on and remains in this position until the control contact S is closed again or until the supply voltage U is interrupted. Closing of the control contact S resets the thus far measured time and starts the new interval T.

ON / OFF - Permanent switching on / off.

The functions ON and OFF are selected with T time range adjusting knob. In the ON function, the normally open contacts are closed all the time whereas in the OFF function they are open. The position of the function-adjusting knob is of no significance in these functions as is the preset measurement time. The ON or OFF functions are used for the time relay operation control in electric systems.

Additional functions

Supply diode: it is lit permanently when the time is not being measured. In course of the T time measurement, it flashes at 500 ms period where it is lit for 50% of the time, and off for 50% of the time.

Adjustment of the set values:

- the values of time and range are read in the course of the relay's operation. The set values may be modified at any moment,
- no change of the function is possible in the course of the relay's operation. Any change of the settings of the relay shall be read only after the supply voltage has been switched off and on again.

Triggering: depending on the function to be performed, the relay is triggered with the supply voltage or by connection of the S contact to the A1 line. For DC supply, the positive pole must be connected to the A1 line. The level of the S contact activation is adjusted automatically depending on the supply voltage.

Supply:

- **RPC-...-A230:** the relay may be supplied with AC voltage 48...63 Hz of 207...253 V,
- **RPC-...-UNI:** the relay may be supplied with DC voltage or AC voltage 48...63 Hz of 10,8...264 V.

Dimensions

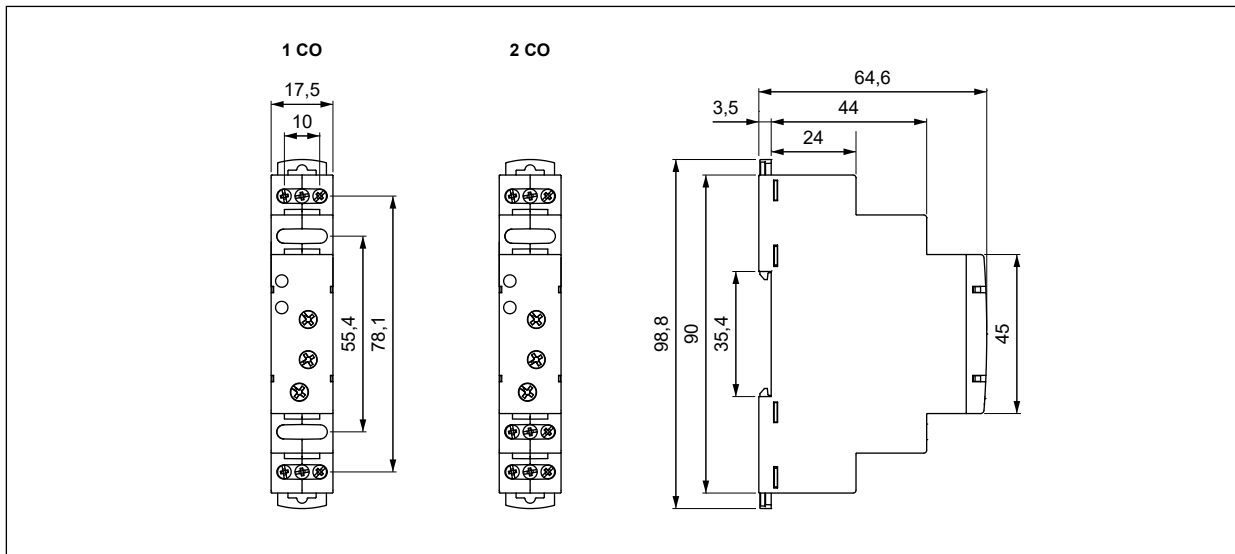

Front panel description

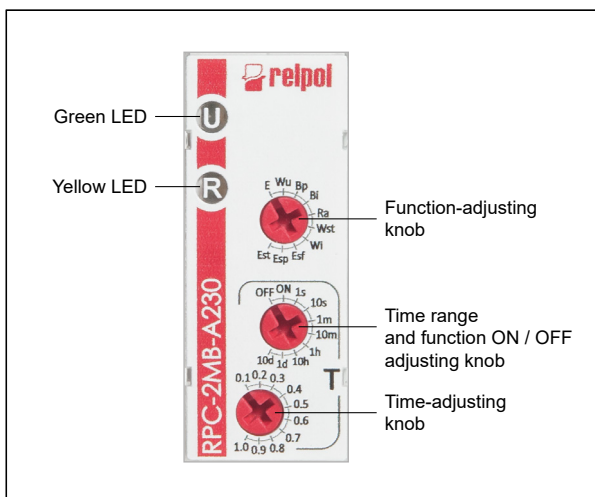

Connection diagrams

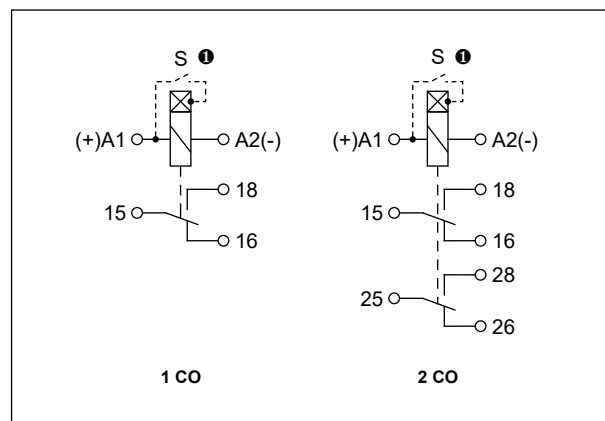

Note: the indicated polarization of the supply refers only to the relays RPC-...-UNI. **!** The control terminal S is activated by connection to A1 terminal via the external control contact S.

Mounting

Relays **RPC-.MB-...** are designed for direct mounting on 35 mm rail mount acc. to EN 60715. Operational position - any. **Connections:** max. cross section of the cables: 1 x 2,5 mm² (1 x 14 AWG), stripping length: 6,5 mm, max. tightening moment for the terminal: 0,5 Nm.



Two catches:
easy mounting
on 35 mm rail,
firm hold
(top and bottom).

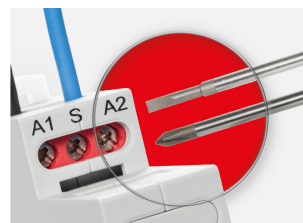

**Mounting wires
in clamps:**
universal screw
(cross-recessed
or slotted head).

Ordering codes

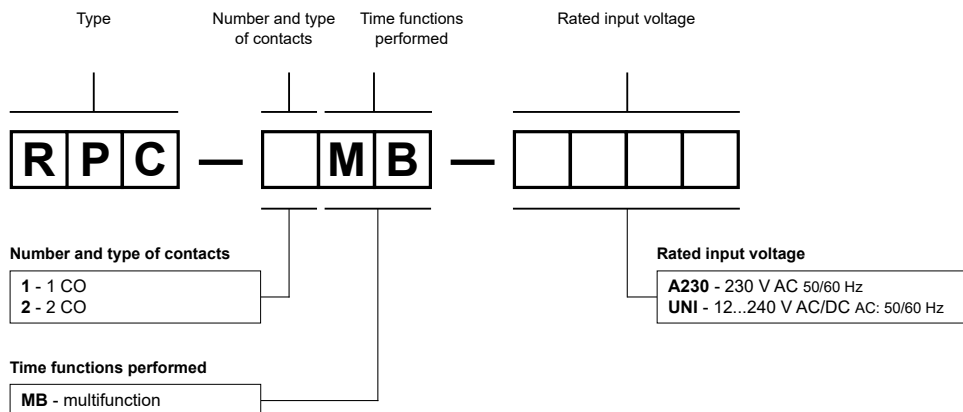

Examples of ordering codes ⑥:

RPC-1MB-A230 time relay **RPC-.MB-...**, multifunction (relay perform 10 functions), cover - modular, width 17,5 mm, one changeover contact, contact material AgSnO₂, rated input voltage 230 V AC 50/60 Hz

RPC-2MB-UNI time relay **RPC-.MB-...**, multifunction (relay perform 10 functions), cover - modular, width 17,5 mm, two changeover contacts, contact material AgSnO₂, rated input voltage 12...240 V AC/DC AC: 50/60 Hz

⑥ Ordering codes **RPC-.MB-...** are specified in Table 1, "Time relay code" column.

Table of codes

Table 1

Time relay code		Rated input voltage
with 1 CO contact	with 2 CO contacts	
RPC-1MB-A230	RPC-2MB-A230	230 V AC 50/60 Hz
RPC-1MB-UNI	RPC-2MB-UNI	12...240 V AC/DC AC: 50/60 Hz

PRECAUTIONS:

1. Ensure that the parameters of the product described in its specification provide a safety margin for the appropriate operation of the device or system and never use the product in circumstances which exceed the parameters of the product. 2. Never touch any live parts of the device. 3. Ensure that the product has been connected correctly. An incorrect connection may cause malfunction, excessive heating or risk of fire. 4. In case of any risk of any serious material loss or death or injuries of humans or animals, the devices or systems shall be designed so to equip them with double safety system to guarantee their reliable operation.